

Lewis D. Smith
P. O. Box 914
Elizabethtown, NC 28337

Bennett Smith Family Lands

Bladen Co., N. C.

Compiled from Bladen Co. Deed Books & Land Grants

By: Richard C. Booth, P.E. & P.L.S.

Smith Lands in NE Bladen

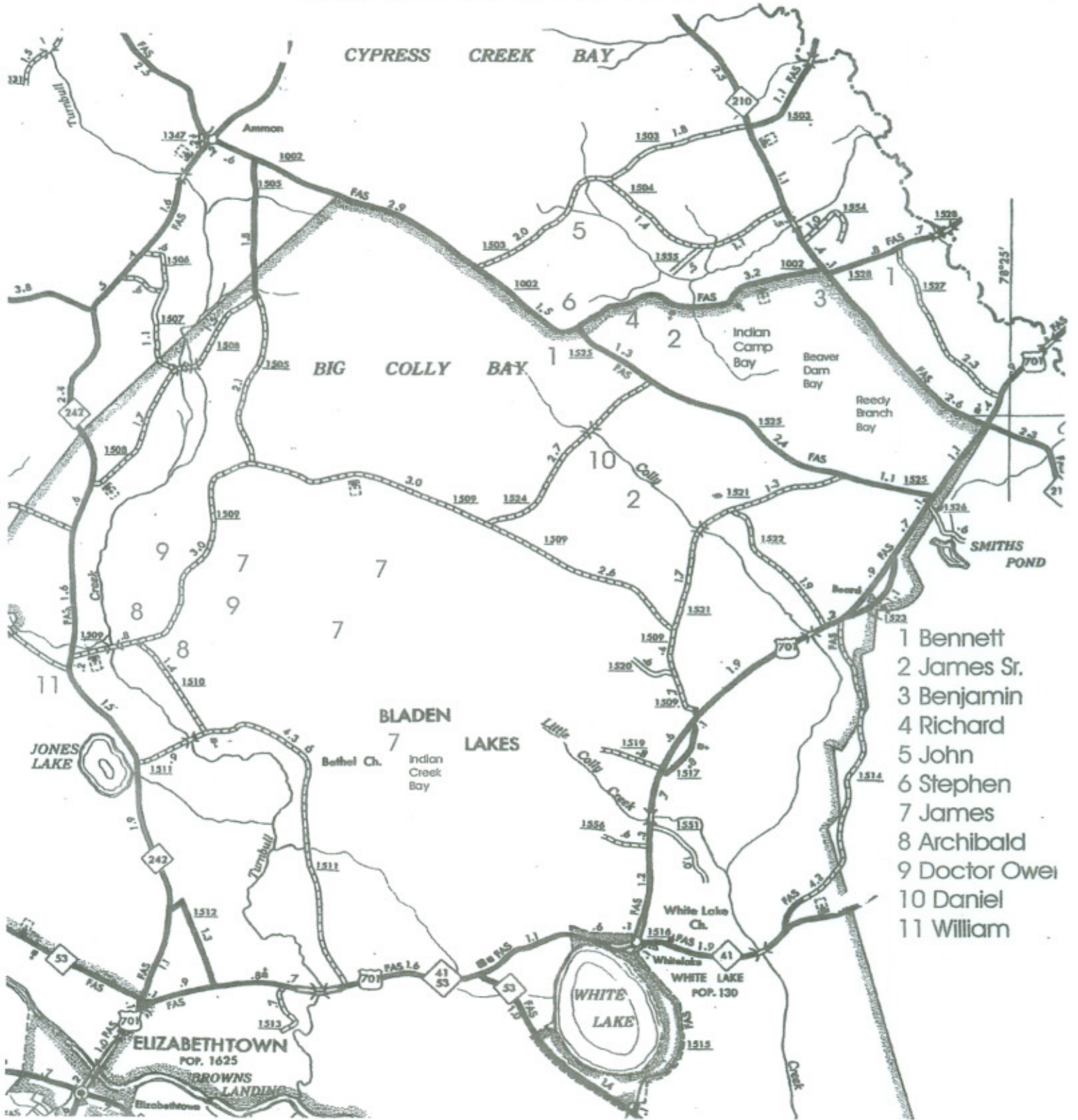

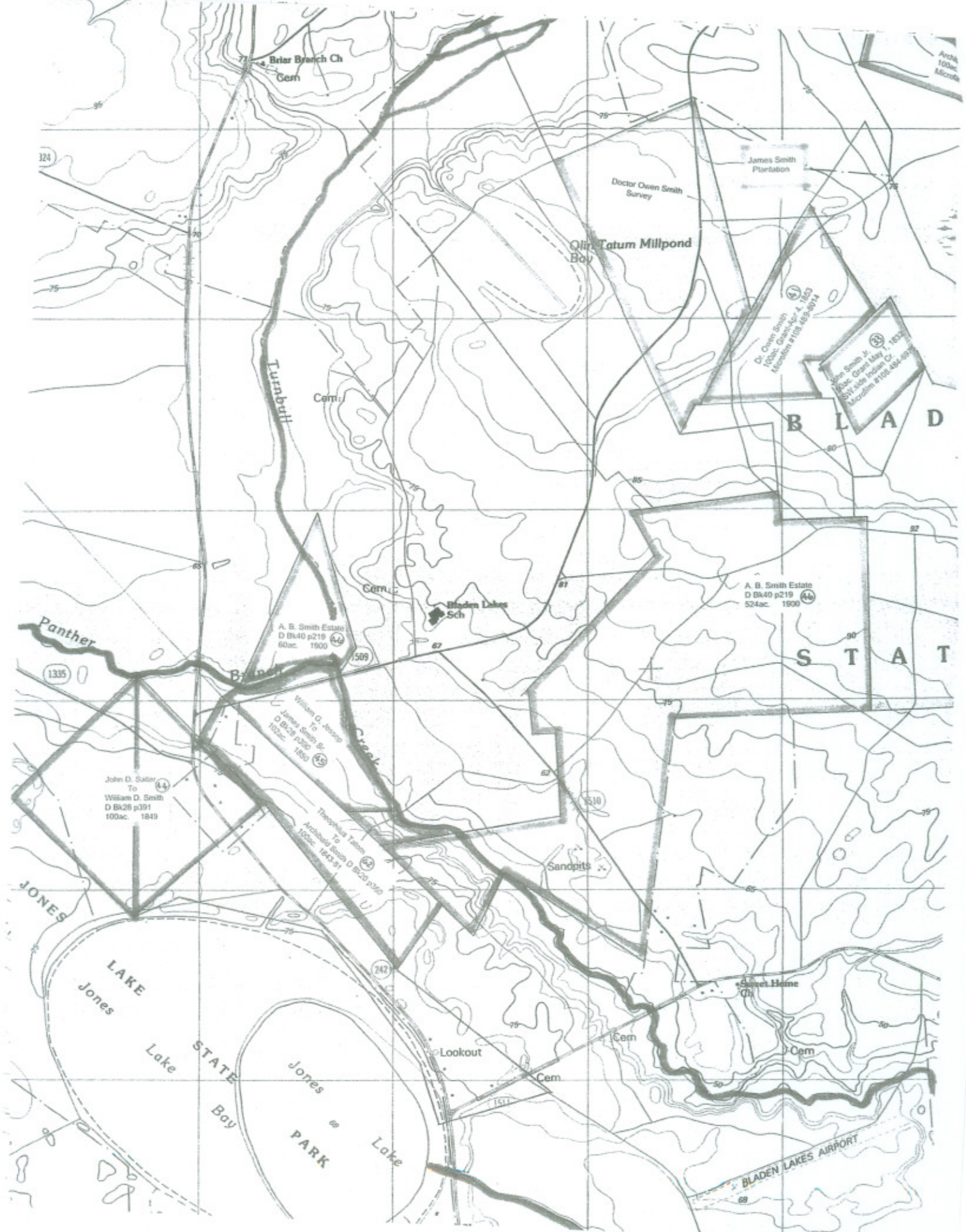

BLADEN STATE

A. B. Smith Estate
D Bk40 p219
524ac. 1900

John D. Sabin
To
William D. Smith
D Bk26 p391
100ac. 1849

A. B. Smith Estate
D Bk40 p219
60ac. 1900

William O. Joseph
To
James Smith Jr.
D Bk26 p392
100ac. 1850

Theophilus Tamm
To
Archibald Smith
D Bk20 p350
100ac. 1843-51

Doctor Owen Smith
Survey

James Smith
Plantation

Dr. Owen Smith
100ac. Grants, Sr. 1, 1823
Acquisition #108 189-8014

John Smith Jr.
100ac. Grant May 1, 1823
BY Sale Indian Cr.
Microfilm #108 184-897

A. B. Smith Estate
D Bk40 p219
524ac. 1900

John D. Sabin
To
William D. Smith
D Bk26 p391
100ac. 1849

A. B. Smith Estate
D Bk40 p219
60ac. 1900

William O. Joseph
To
James Smith Jr.
D Bk26 p392
100ac. 1850

Theophilus Tamm
To
Archibald Smith
D Bk20 p350
100ac. 1843-51

Doctor Owen Smith
Survey

James Smith
Plantation

Dr. Owen Smith
100ac. Grants, Sr. 1, 1823
Acquisition #108 189-8014

John Smith Jr.
100ac. Grant May 1, 1823
BY Sale Indian Cr.
Microfilm #108 184-897

A. B. Smith Estate
D Bk40 p219
524ac. 1900

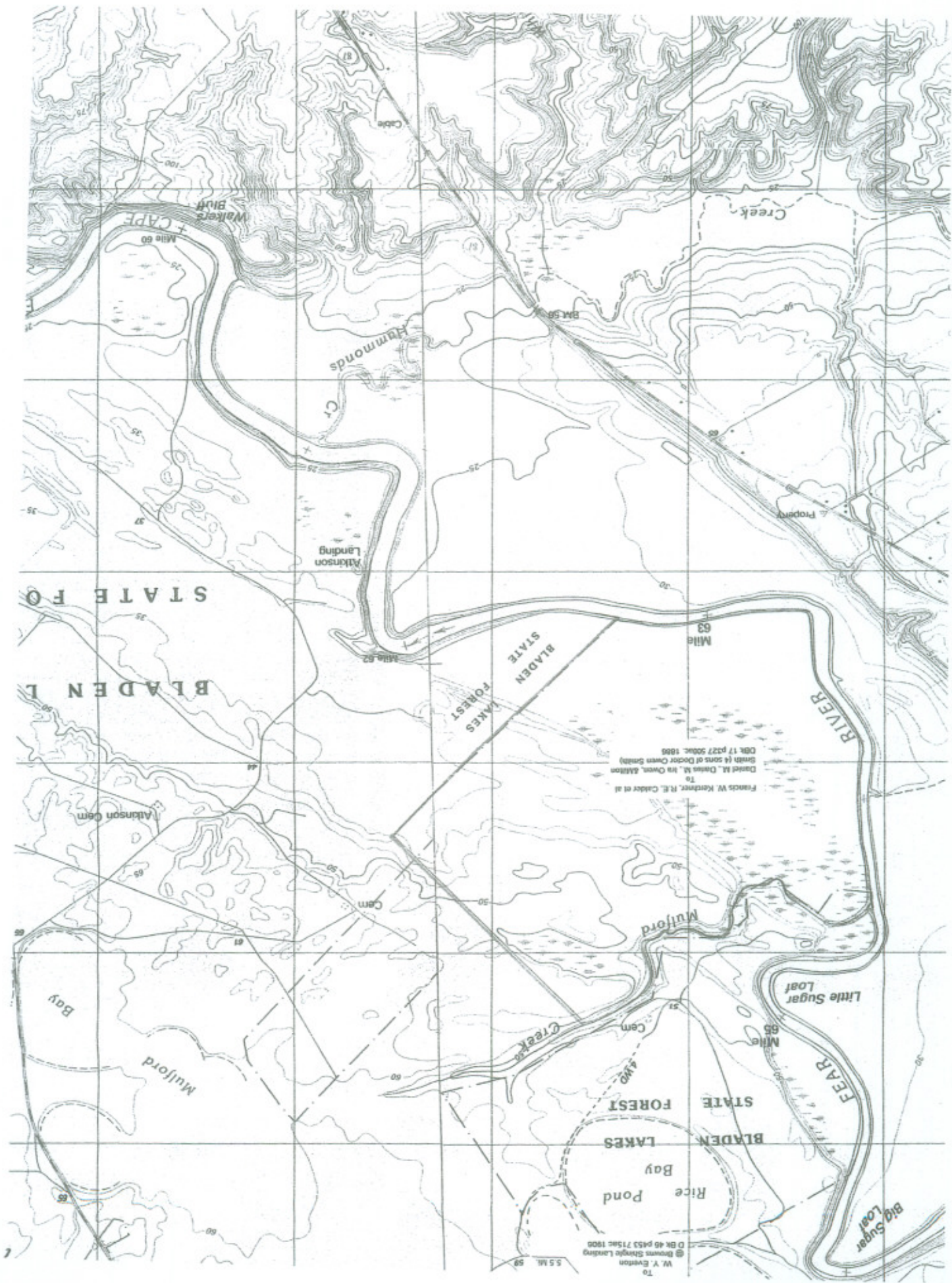

BLADEN L
STATE FO

To
W. Y. Ewerton
@ Bladen State Forest
D. R. 46 p. 653 715a. 1900

To
Francis W. Keady, R. E. Caddy et al
David M. Owen, M. H. Owen, S. A. Owen
Death of sons of Doctor Owen Smith
D. R. 17 p. 27 500a. 1886

7

**Smith's on Indian Camp Bay
Land Transactions**

<u>Date</u>	<u>From</u>	<u>To</u>
1782	Grant	Bennett Smith planter of Sampson Co. 200ac.
May 13, 1802	Bennet Smith	(1)Son Richard Smith D Bk 27 p494 200ac on N.side Colly Swp Wit: Wm. Blackburn & Shadrack Smith
Mar 15, 1831	Richard Smith	James Cromartie 200ac (1st of three tracts) D Bk10 p275 Wit: R. Reeves & Tryon Smith
Feb 9, 1797	Grant	(2)Richard Smith 200ac. North of Sandy Point Br. Microfilm #108.494-0636
Jul 10, 1802	Grant	(3)Richard Smith 100ac. Joining self & Cromatie Microfilm #108.476-5306
1831	Richard Smith	CC James Smith & Garland Cain James Cromartie D Bk 10 p275
Sept 25, 1804	Grant	(29)Benjamin Smith 50ac. Joins Alex. Henry, Rob. McMillan & self Microfilm #108.494-0696
Oct 17, 1806	Grant	(30)Ezekiel Smith 50ac. On E.side of Indian Camp Bay joins Benjamin Smith & Robert Henry. CC: Benj. & John Smith Microfilm #108.494-0658

Aug 5, 1817	Grant	(28)Ezikel Smith 50ac. E.side Indian Camp Bay, joining Peter Cromartie Microfilm #108.483-6708
Aug 15, 1825	Ezekel Smith	Duncan Robertson 50ac. D Bk30 p49
Aug 10, 1871	Alfred Smith & wife Isabella, Daniel Simmons & wife Nancy, Sion Robinson & wife Eliz., Arch. Robinson & wife Sarah M., Wm. Robinson & wife Mary Jane, Malcolm Robinson & wife Eliz., & Catherine Robinson	Daniel Robinson 50ac. D Bk45 p228
1803-1818	Daniel G. Campbell	(4)James Smith Sr. 250ac Grant No. 1109 Microfilm #108.478-5674 Mar 26, 1803 Joins Bennett Smith & Indian Camp Bay
Aug 3, 1818	James Smith Sr.	John B. Smith 250ac D Bk29 p517
May 2, 1825	John B., James, & Charles Smith	James Cromartie 250ac D Bk11 p392

Smith's on Beaverdam & Mirey Bays Land Transactions

<u>Date</u>	<u>From</u>	<u>To</u>
Jan 1773	Grant	William Cromartie 300ac. On both sides of Mirey Branch. Joins Bennett Smith's Plantation Microfilm #108. (Not located)
Mar 2, 1775 Feb 2, 1795	Grant Thomas Devane Sr.	Thomas Devane Sr. of N. H. Co. 200ac. (11) Benjamin Smith D Bk27 p204 Wit: Bennet Smith & John Devane Jr.
Apr 7, 1817	Benjamin Smith	Peter Cromartie D Bk 6 p582
Sep 25, 1804	Grant	(12) Benjamin Smith 50ac. Joins Henry, McMillan & self Microfilm #108.494-0695
Sep 28, 1807	Grant	(13) John G. Morris 50ac. On Beaverdam Bay Microfilm #108.480-6254 CC: J. Smith & B. Smith
Jan 10, 1810 Apr 7, 1817	John G. Morris Benjamin Smith	Benjamin Smith D Bk 29 p165 Peter Cromartie D Bk 6 p582
Oct 17, 1806	Grant	(14) Ezekiel Smith 50ac. On S.side Beaverdam Bay CC Benj. & John Smith Microfilm #108.494-0657
Aug 7, 1828	Robert McMillian	(15) Peter Cromartie D Bk 30 p215 -4th tract Calls for "Smith's Tar Landing" on (South) River - not located.

8

Smith's on Sandy Point Bay Land Transactions

<u>Date</u>	<u>From</u>	<u>To</u>
Jul 31, 1779	Grant	(16)James Smith 200ac. In Colly Swp. CC: - D. Smith & Rich. Smith Microfilm #108.494-0669
Mar 20, 1801	Grant	(17)James Smith 50ac. Near mouth of Sandy Point Br. Joins Richard Smith CC Richard Smith & Jacob Long Microfilm # 108.477-5537
Aug 3, 1818 Dec 23, 1831	James Smith John B. Smith	John B. Smith D Bk29 p522 James Cromartie D Bk10 p161
Nov 10, 1801	Grant	(18)James Smith 50ac. On S.side of Big Colly. CC: Richard Smith & Jacob Long Microfilm # 108.478-5816
Oct 7, 1813	David W. Kemp	(19)John B. Smith 200ac. a Jul 21, 1779 Grant to John Haney now occupied by James Smith who lost it because of Unpaid taxes for the year of 1807 D Bk 7 p531
Aug 18, 1814	Grant	(20)James Smith 100ac. On N.side Big Colly Swp. Joins James Cromartie & Richard Smith CC: Tom & James Smith Microfilm #108.482-6551
Aug 3, 1818	James Smith Sr.	John B. Smith D Bk29 p518
Mar 7, 1818	Grant	(21)James B. Smith 300ac. Including Sandy Point Bay. CC: James Smith Sr. & John Smith Microfilm #108.494-0671

Aug 3, 1818

James Smith Sr.

(22)John B. Smith 50ac. On E.side Colly
Swp. D Bk29 p519

Feb 19, 1825

Grant

Allen Smith 100ac. On E.side of Sandy
Point Bay, joins John B. Smith.
CC: Richard & Alfred Smith
Microfilm #108.494-0694 (not located)

Aug 22, 1835

Grant

(61)Benjamin Smith Jr. 50ac. On W.side of
Sandy Point Bay. Joins John B. Smith,
& Richard Smith Sr.

Smith's on Reedy Branch Bay Land Transactions

<u>Date</u>	<u>From</u>	<u>To</u>
Aug 4, 1795	Grant	(23)James Smith 100ac. E.side of Colly On lower side of Reedy Br. Microfilm #108.475-5085
? Aug 2, 1830	James Smith John B. Smith	John B. Smith Alexander Cromartie D Bk 28 p472 11th tract
Mar 15, 1802	Grant	(24)James Smith 150ac. NE.side Big Colly CC Richard Smith & Jacob Long Microfilm #108.478-5754
Dec 1, 1800	Grant	(25)James Smith 50ac. On S.side Reedy Br. D Bk27 p245
Aug 3, 1818 Aug 15, 1829	James Smith Sr. John B. Smith	John B. Smith D Bk29 p521 Shadrack Smith 1st tract in D Bk10 p74
Apr 16, 1803	Grant	(26)James Smith 50ac. Near Colly Swp. Microfilm #108.478-5814
Aug 15, 1829	John B. Smith	Shadrack Smith 2nd tract in D Bk10p74
Jul 10, 1805	Grant	(27)James Smith 150ac. On E.side of Colly including part of Beaverdam Bay CC: Richard Smith & James Smith Jr. Microfilm #108.494-0667 (All of this 150ac. became part of a 300ac. Grant to John B. Smith Nov 6,1815 Microfilm # 108.482-6552
Aug 15, 1825	Thomas Johnson	James Smith Jr. 80ac. Between Reedy Bay & Indian Cr. It being part of a 150ac. Grant to Wm. White dated 1800 Then conveyed to Joel Johnson. D Bk28 p119 (not located)

Smith's on Indian Creek/Horsepen Bay Land Transactions

<u>Date</u>	<u>From</u>	<u>To</u>
Oct 11, 1800	Grant	William White 150ac. On NW.sideof Indian Cr. & Caine Meddow Microfilm #108.477-5518
?	William White	Joel Johnson
?	Joel Johnson	Thomas Johnson
Aug 15, 1825	Thomas Johnson	James Smith Jr. 80ac. Of the 150ac. Wit: Jesse Blackwell & David Johnson D Bk28 p119 (not located)
Nov 24, 1813	Grant	Abel Burney 200ac. edge of Indian Cr.
May 2, 1814	Abel Burney	Wm. Hendon
1814-1817	Wm. Hendon	Samuel Bordeaux
Nov 25, 1817	Samuel Bordeaux	(31)James Smith 100ac.(part of the 200ac.) Wit: Isaac Jones & Felix Blackburn D Bk 28 p558
Jan 18, 1821	Eliazer Russ	(32)John Smith Jr. 50ac. Part of 400ac. Grant to Wm. Hendon May 11 1808 on Indaian Cr. Wit: James Carroll & John B. Smith. D Bk11 p386
May 1, 1832	Grant	(33)John Smith G. 50ac. E.side of Turnbull Cr & SW.side Indian Cr. CC: Daniel Smith & ? Smith Microfilm #108.484-6975 & Dbk10p123
Jun 18, 1844	Grant	(34)James Smith 100ac. On NE.end of Cany Meadow Bay near Johnson's Mill Bay D Bk28 p97 & Microfilm #108.485-7355

Jun 18, 1844	Grant	(35)Milton J. Smith 100ac. On Cainy Meadow joins self, James Smith & Mary Smith. D Bk28 p66 & Microfilm #108485-7356
Jun 18, 1844	Grant	(36)Archibald Smith 100ac. On NE.side Indian Cr. Joining Pridgen , Joshua Tatom & James Smith D Bk28 p151 & Microfilm #108.485-7357
Feb 22, 1849	Grant	James J. Smith 20ac. On NE.side of Indian Cr. Joins his own line of a 100ac. Survey & Johnson. CC: James Smith & W. Johnson Microfilm #108.487-7689 & D Bk28 p405 (not located)
Feb 19, 1849	Grant	(37)Archibald Smith 20ac. On E.side Little Indian Cr. Joins Wm. Johnson & 42ac. Survey of James Smith CC: James & Robert Smith Microfilm #108.487-7690
Aug 9, 1849	Grant	(38)William Smith 50ac. On S.side Indian Cr. Joins McKay & James Smith CC: John Smith Microfilm #108.487-7608
Nov 16, 1850	James J., John, Elizabeth, Susenah Smith & Mary Smith	James Smith Sr. the above 50ac. (William has died) Prov: Robert Smith D Bk28 p494
Dec 17, 1849	Grant	(39)James Smith 100ac. On S.side Indian Cr. Joining self (called Handon lands) & Bordeaux CC: Sion & Daniel Smith. Microfilm #108.488-7912

Dec 17, 1849	Grant	(42)James Smith 100ac. On S.side Indian Cr. Joining self, McInish & McKay CC: Sion & Daniel Smith. Microfilm #108.488-7913
Jun 8, 1850	Grant	(40)James Smith 100ac. On N.side of Indian Cr. In Caaney Medow joins Archibald Smith & J. J. Smith. CC: Edward Davis & A. Smith Microfilm #108.489-8010
Dec 11, 1852	Grant	Sion Smith 100ac. On SW.side of Indian Cr., Opposite Wm. Parkers house & joins Cromartie. CC: John Smith & John G. Cowan Microfilm #108.488-7904 (not located)
Apr 4, 1853	Grant	(41)Dr. Owen Smith 100ac on Horsepen Bay & W.side of Indian Cr. Joins James Smith's Plantation survey. CC: Edward Davis & Sion Smith Microfilm #108.489-8014
Oct 1, 1866	Robert Smith Admin. James Smith decd.	(43)Ollen Tatum 74ac. Between Turnbull & Indian Creek. D Bk38 p456

**Smith's on Turnbull Cr./Panther Br.
Land Transactions**

<u>Date</u>	<u>From</u>	<u>To</u>
Apr 18, 1814	Solomon Davis	John Smith 200ac. On E.side of Turnbull above Big Br. near Parkers Wit: Isaac Jones & E. Smith D Bk11 p168 (not located)
Apr 1820	John Smith	William West D Bk11 p487
Jan 15, 1816	William Reeves	Benjamin Smith 80ac. On E.side of Turnbull & joins Grant of Isaac Jones. D Bk10 p14 (not located)
Jul 3, 1818	Benjamin Smith	Robert Melvin D Bk11 p532
Feb 7, 1820	James Cook	John Smith 102ac. On E.side of Jones Cr. Granted John White. Wit: A.Culbrith & Jas. Smith D Bk37 p474
Mar 5, 1840	James Smith Sr.	William Smith, son 2 tracts og 162ac. 1st 102ac. Above 2nd 60ac. Joins Wm. White, Mathew & Thomas. Wit: J. G. Sutton & James Carroll D Bk8 p569 (not located)
Sept 29, 1820	Grant	John Smith 20ac. On NE.side of Turnbull, joins Jesse Tatom, Saltar, Robeson & own 102ac. Tract. Microfilm #108.483-6766 (not located)
Apr 14, 1838	John Smith G.	Theophilus Tatom 20ac. Wit: Daniel L. Smith & Thomas B. Cowan D Bk22 p209

May 7, 1823	Samuel Robinson & wife Elizabeth E.	John Smith 4 tracts on E.side of Turnbull & S.side of Indian Cr. 1st tract 228ac. Grant to John Ellis Dec 6, 1799. Microfilm #108.475-5136 2nd tract 100ac. Grant to John Ellis Jan 11, 1786 Microfilm #108.475-5207 3rd tract 60ac. Grant to John Ellis Feb 11, 1799 Microfilm #108.476-5399 4th tract 200ac. Grant to John Ellis Dec 23, 1799 Microfilm #108.477-5572
Apr 14, 1838	John Smith G.	D Bk11 p170 (not located) Theophilus Tatum 2nd tract above Wit: Daniel L. Smith & T. B. Cowan D Bk22 p216
Nov 10, 1830	James Smith	James Carroll 4th tract above Wit: Sam. Johnson & James Armstrong D Bk10 p50
Nov 5, 1828	Griffith J. White	John Smith Gri ? 115 ac on NE.side of Turnbull & runs with it & joins James Cook. D Bk30 p254 (not located)
Aug 16, 1833	John Smith	Daniel Smith (now 100ac.) Wit: James Smith & Syon Long. D Bk10 p129
Mar 5, 1840	James Smith Sr.	John Smith, his son (now 115ac.) Wit: J. G. Sutton & James Carroll D Bk 8 p570
Apr 3, 1852	John Smith	John G. Sutton Wit: John Buie & H. R. Francis. D Bk3 p354
Aug 3, 1833	John Smith	Theophilus Tatom 280ac. On S.side of Jones Cr. Wit: James Carrol & John Long. D Bk10 p106 (not located)

Jul 28, 1834	Grant	Daniel Smith 80ac. On NE.side Jones Br. Joins Theophilus Tatom & John Smith. CC: John Smith & John Bordeaux. Microfilm #108.484-7083 (not located)
Aug 4, 1834	Grant	Theophilus Tatom 100ac. On NE.side of Turnbull Cr. Joins his own 40ac. Survey, Daniel Smith's 80ac. Survey & James Smith's 200ac. Survey. CC: Daniel Smith & John Bordeaux Microfilm #108.484-7084 (not located)
May 7, 1839	Grant	James Smith Sr. 25ac. E.side Turnbull Joins self, Saltar & Tatom. Microfilm #108.485-7330 (not located)
Oct 21, 1843	Grant	(62)Theophilus Tatom 100ac. On W.side of Turnbull Cr. & lower side Panther Cr. Joins self, T. D. Salter, Wm. Smith, Daves & Weston. Microfilm #108.486-7434
? Mar 1, 1881	Theophilus Tatom Archibald Smith & wife Julia Ann	Archibald Smith 100ac. Kerchner & Calder Brothers of Wilmington 100ac. D Bk20 p360
Feb 20, 1845	John G. Sutton	James, William D., & Archibald Smith 100ac. Joins Isaac Roberts D Bk8 p513 (not located)
Oct 20, 1849	John D. Salter	(44)William D. Smith 100ac on lower side Panther Br. Half of a 200ac. 1765 Grant to David White the other half owned by John Smith D Bk28 p391
Jan 28, 1850	William G. Jessop	(45)James Smith Sr.102ac. on S.side of Turnbull @ mouth of Panther Br. D Bk28 p390

Jul 2, 1852	Grant	James Smith 100ac. Between Turnbull & Colly @ NE.end of Lake Swp Microfilm #108.488-7877 (not located)
Dec 15, 1852	Grant	John & Sion Smith 156ac. On NE.side Turnbull Swp on N.edge of Cow Br. A little above the road, joins Theophilus Tatom, Arch.Smith & Merritt. CC: T. Tatom & D. O. Smith Microfilm #108.488-7905 (not located)
Jan 1, 1869	L. A. Tatom	Archibald Smith 175ac. & 100ac. OnTurnbull and below Panther Br. Wit: H. R. Francis. D Bk15 p81 (not located)
Sept 27, 1900	A. B. Smith Estate	(46)Nine lots of 584ac. On Turnbull & (46a)Panther Br. D Bk40 p219

Oct 3, 1804	Grant	William Blackburn 100ac. On S.side Big Colly joining Daniel Melvin & James Harrington Microfilm #108.492-0240 (not located)
Sept 12, 1805	Grant	Burrel Blackburn 300ac. On E.side Colly Swp & joins his own Swcorner CC: Wm. Blackburn & Richard Smith Microfilm #108.492-0241
Jul 16, 1806	Grant	William Blackburn 300ac.(320ac.) On W.side Colly
Aug 1834	William Blackburn Hiram Blackburn	Hiram Blackburn (son) Mary Smith (50) 1st tract - 300ac. On W.side Colly @ head of Indian Creek (47) 2nd tract - 100ac. N. Of 1st tract (1782 grant to Wm. Toler) (48) 3rd tract - 100ac. Joins Toler-2nd tract 4th tract - 50ac. @ mouth of Horsepen Br. (not located) (51) 5th tract - 100ac. S.side Colly (49) 6th tract - 100ac. 7th tract - 50ac. S.side Big Colly & joins J. Thomas (not located) Wit: Philix & Hiram Blackburn. D Bk22 p325
Jun 2, 1801	Grant	(65) James Smith 50ac. E.side Big Colly Bay joins Waddle line. CC: Benjamin Smith & Eleazor Russ Microfilm #108.477-5563
? Aug 23, 1851	James Smith John B. Smith Sr.	John B. Smith Joel Johnson 50ac. D Bk30 p555
Feb 4, 1804	Grant	James Smith 105ac. SW.side Big Colly Swp. Near W.corner of his 50ac. Survey CC: Ezekiel Smith & James Smith Jr. Microfilm #108.494-0668 (not located)

Jan 13, 1807	James Harrington	(56) Richard Smith 50ac. On S.side Big Colly by Bear Path. D Bk29 p166 (Also D Bk12 p166 same deed) Daniel Smith D Bk10 p51
Aug 12, 1832	Richard Smith	
Aug 3, 1818	James Smith Sr.	John B. Smith 50ac. D Bk29 p516 (not located)
Oct 4, 1814	Grant	Ezekeil Smith 100ac. Between Colly Bay & Wm. Richardson CC: Tom? Smith & John Long Microfilm #108.482-6586 (not located)
Jan 10, 1817	Ezekie Smith	William Reeves 100ac. D Bk37 p336
Jan 5, 1824	William Reeves	John Smith 241ac. On E.side Colly Swp Joins Anders & Waddells line & E. Burke Wit: R. Reaves & Ruben Fisher D Bk11 p265 (not located)
Oct 9, 1826	Grant	(63) Alfred Smith 50ac. E.side of Colly joins Richard Smith & Wm. Robeson. CC: Richard Smith & Allen Smith Microfilm #108.494-0693
Mar 15, 1832	Grant	(64) Alfred Smith 100ac. On E.side of Colly Swp. Joins his own corner & N.corner of Josiah Sykes 200ac. Grant & Evans Bown. D Bk10 p101
Jan 31, 1832	Grant	John Smith Sr. 50ac. N.side of Colly Swp. joins James Cromartie, Wm. Robeson & Daniels Microfilm #108.484-6997 (not located)
Apr 2, 1845	John Smith Sr.	John Cain 50ac. Wit: Mathew McBride & Allen Smith D Bk14 p466 (not located)

**Smith's on W.side of the South River
Land Transactions**

<u>Date</u>	<u>From</u>	<u>To</u>
May 3, 1769	Grant	Bennett Smith 100ac. On W.side of South River, being a place called Watry hole (no survey given) Microfilm #108.494-0695 (not located)
Aug 20, 1778	Grant	Bennett Smith 200ac. Between Colly Swp. & Cypress Cr., includes a place called the watering hole. CC: Chris Sutton & Dan Melvin. Microfilm #108.468-3358 (not located)
Nov 20, 1786	Grant	John Melvin 100ac. SW.side of South River Microfilm #108.473-4661 (not located)
? Feb 2, 1817	John Melvin Benjamin Smith	Benjamin Smith 100ac. D Bk29 p491 Jonathan Davis 100ac. D Bk29 p491
Mar 4, 1806	Grant	Robert Melvin 50ac. On W.side of South River, joining Benjamin Smith, Robeson & McMillian CC: Benj. Smith & D. Robeson Microfilm #108.480-6159 (not located)
Oct 23, 1802	Grant	Benet Smith 50ac. On South River Joins Robert McMillan CC: Richard & John Smith Microfilm #108.494-0737
Aug 9, 1815	Grant	John Cromartie 375ac. NW.side of South River, above Smith's Tar Landing Microfilm #108.482-6575 (not located)

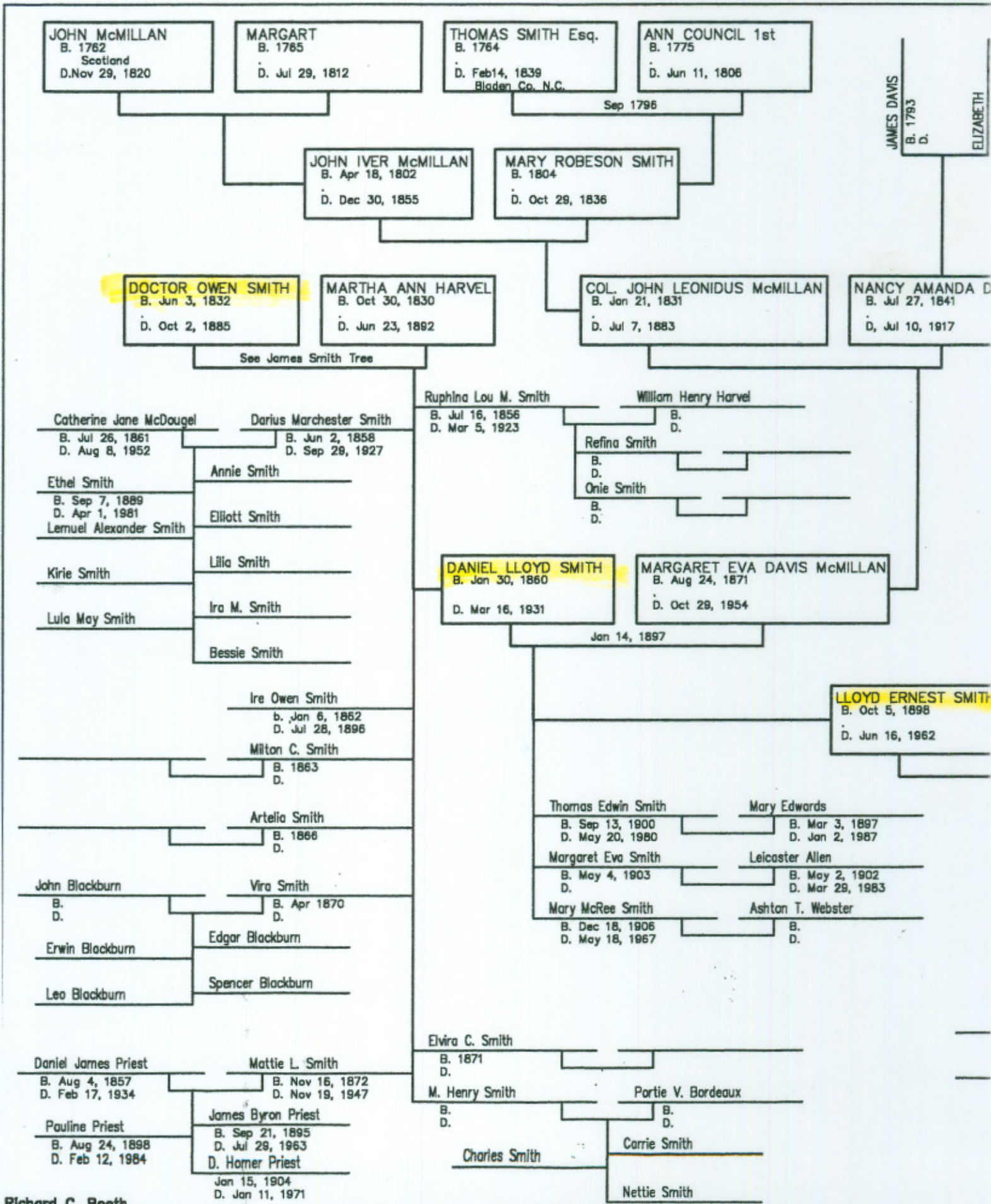

Richard C. Booth
 110 Dundee Ct.
 Cary, N. C. 27511-6514
 919-467-0582 Fax 467-8333

Lewis D. Smith
P. O. Box 914
Elizabethtown, NC 28337

ART

4 Daniel Lloyd Smith
G.F.
B 30 January 1860
D 16 March 1931
M 14 January 1897
Res. Bechtow County, N.C.

5 Margaret Eva Davis McMillan
G.M.
B 24 August 1871
D 29 October 1954

8 Doctor Owen Smith
G.G.F.
B 3 June 1832
D 2 October 1885
M
Res.

9 Martha Ann Harvel
G.G.M.
B 30 October 1830
D 23 June 1892

10 Col. John Leonidas McMillan
G.G.F.
B 21 January 1831
D 7 July 1883
M
Res.

11 Nancy Amanda Davis
G.G.M.
B 27 July 1841
D 10 July 1917

16	James Smith SR 1787 1856	32	JAMES SR 1755-1869	64	BENNETT 1774
B				65	HARRITA 1810
D		33	RACHEL	66	
M				67	
Res.				68	
		34		69	
		35		70	
				71	
		36		72	
				73	
		37		74	
				75	
		38		76	
				77	
		39		78	
				79	
		40	John McMillan B. 1762 in Scotland D. 29 September 1820 in Bechtow Co. N.C.	80	
				81	
		41	Margaret B. 1765 in Scotland D. 25 July 1812	82	
				83	
		42	Thomas Smith	84	
				85	
		43	Mary Ann Council	86	James Council
				87	Mary Robeson
		44		88	
				89	
		45		90	
				91	
		46		92	
				93	
		47		94	
				95	
		48	Richard Mullington Lewis B. 20 February 1763 D. 29 February 1844	96	Josiah Lewis 1720 d. m. 12-23-1750
				97	David Mullington 1711 d. 1.
				98	

B 24 August 1011
 D 29 October 1954
 Lewis D. Smith
 P. O. Box 914
 Elizabethtown, NC 28337

6 William Evander Lewis

G.F.
 B 20 February 1860
 D 2 March 1942
 M 30 March 1887
 Res.

7 Mary Rachel Davis

G.M.
 B 7 March 1870
 D 20 December 1955

11 Nancy Amanda Davis
 G.G.M.
 B 27 July 1841
 D 10 July 1917

12 William Simon Lewis
 G.G.F.
 B 16 May 1824
 D 12 August 1880
 M 9 October 1849
 Res. Bladen County, N.C.

13 Sarah Ann Singletary
 G.G.M.
 B 22 April 1829
 D 3 April 1903

14 William Rose Davis
 G.G.F.
 B 11 April 1835
 D 1 April 1924
 M 8 November 1858
 Res. Bladen County, N.C.

15 Catherine McLean
 G.G.M.
 B 1 May 1839
 D 23 May 1924

BDM Res. 1793
 45
 23 Elizabeth
 B D 1804
 46
 47

24 Richard Mulligan Lewis II
 B 6 February 1794
 D 21 September 1856
 48 Richard Mulligan Lewis
 B 20 February 1763
 D 29 February 1844
 49 Sarah Simson
 B 31 August 1769
 D 18 November 1839
 50 John Hester
 51 Comfort

26 Josanna Singletary
 B 1-21-1802
 D 1-21-1840
 52 Jonathan Singletary
 B 16 July 1769
 D 23 January 1865
 53 Sarah Ann Harrison
 B 3-2-1791
 D 4-9-1850
 54 Rev. Dennis Lennon
 B 17 May 1779
 D 16 July 1822
 M 25 November 1800
 55 Sarah (Becki) Brown
 B 29 May 1779
 D 25 May 1958

27 Annis Jane Lennon
 B 1-9-1810
 D 5-1896
 56 GOODFROTH DAVIS JR
 B 1782
 D 1855
 57 REBECCA HESTER
 B 1794
 D 1875

28 Isaac Davis
 B 22 April 1805
 D 26 November 1887
 Res. Bladen County, N.C.
 29 Edith Hester
 B 9 January 1809
 D 14 September 1887
 30 Lanchlin McLean
 B 1760
 D 1779-1859
 31 Mary McRae
 B 1795-1855

48 Richard Mulligan Lewis
 49 Sarah Simson
 50 John Hester
 51 Comfort
 52 Jonathan Singletary
 53 Sarah Ann Harrison
 54 Rev. Dennis Lennon
 55 Sarah (Becki) Brown
 56 GOODFROTH DAVIS JR
 57 REBECCA HESTER
 58
 59 LAUCHLIN 1760
 60 JOHN 1750
 61
 62 Roderick "Gabe" McRae
 63 Nancy McRae

90
 91
 92
 93
 94
 95
 96 Josiah Lewis 1720
 97 Wm. 12-23-1750
 98 Wm. Mullington 4-5-1778
 99 Thomas Simson
 100 Sarah Bryan
 101 Thomas Hester
 102
 103
 104 JOSEPH 1713 5C
 105 MARY FITZGERALD 12-29-1732
 106 Edward Harrison
 107
 108 Dennis Lennon d. 8 Dec 1805
 109 Experience
 110 William Brown II
 111 Anne
 112 SAMPSON DAVIS SR JL
 113 1755 1840 DFC
 114 RUTH BRYANT
 115 1769 1863
 116
 117
 118
 119 JOHN 1750
 120 ANDERSON 1725
 121
 122
 123
 124
 125
 126
 127

Smith Lands in NE Bladen

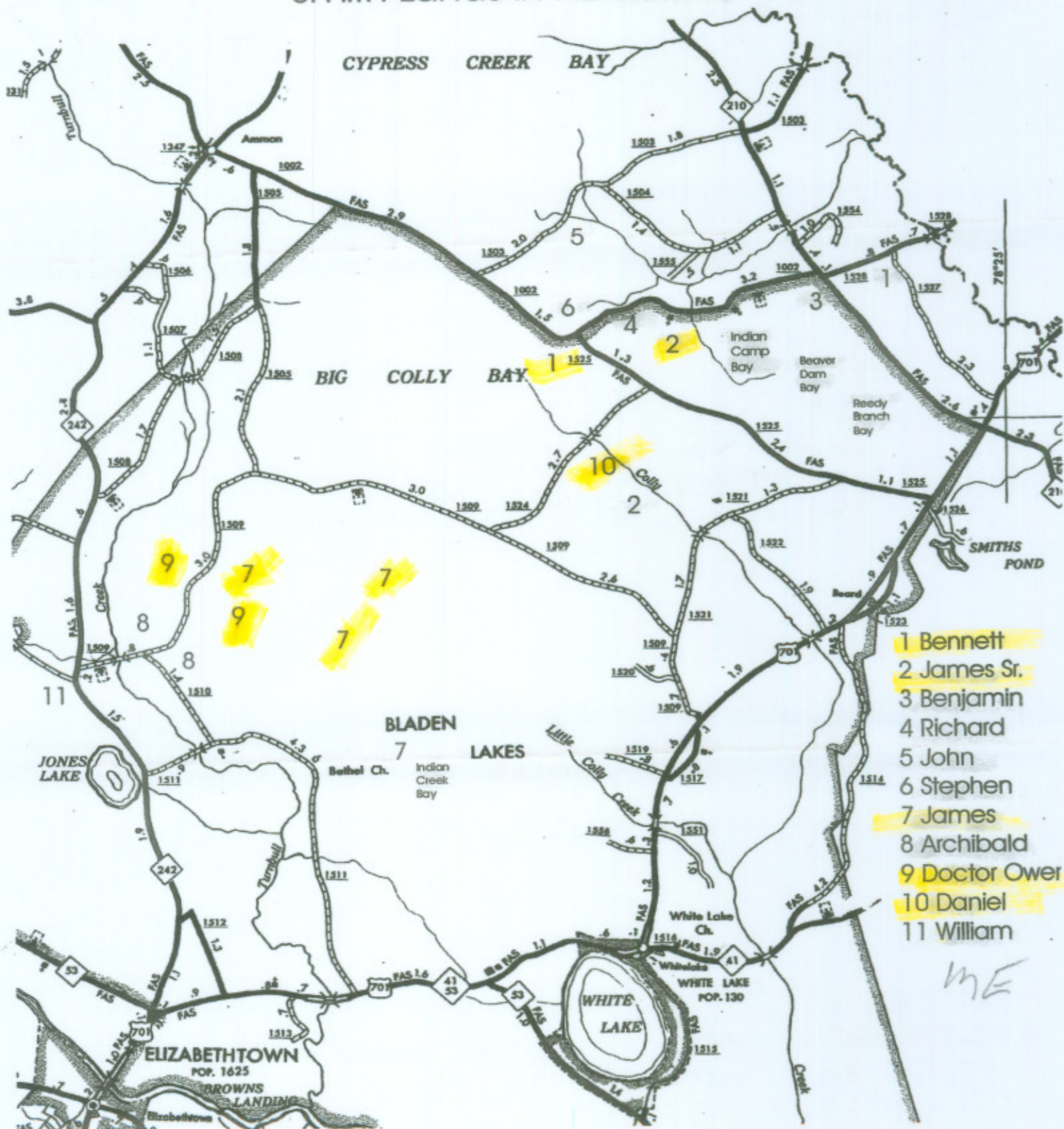

- 1 Bennett
- 2 James Sr.
- 3 Benjamin
- 4 Richard
- 5 John
- 6 Stephen
- 7 James
- 8 Archibald
- 9 Doctor Ower
- 10 Daniel
- 11 William

ME

Bennett Smith

Notes:

- 1840 Stephen Smith married Ann Bennett in Smithfield, Va.
 - 1740 Richard, Drew, Benjamin and Peter Smith are in Northampton Co., N. C.
 Mar 23, 1746 Bennett Smith was a wit. to the Will of John Garner in Northampton Co., N. C.
 Jan 7, 1755 John Garner Sr. to Bennett Smith both of Northampton Co., N. C. 40 ac. joining Main Upperin Rd. & Buckhorn Sm. 161. Richard Smith
 Jun 16, 1755 Bennett Smith sold Charles Sikeser the above 40 ac. Will. Samuel Bennett

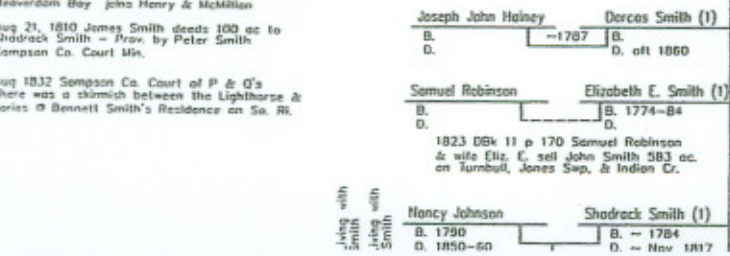
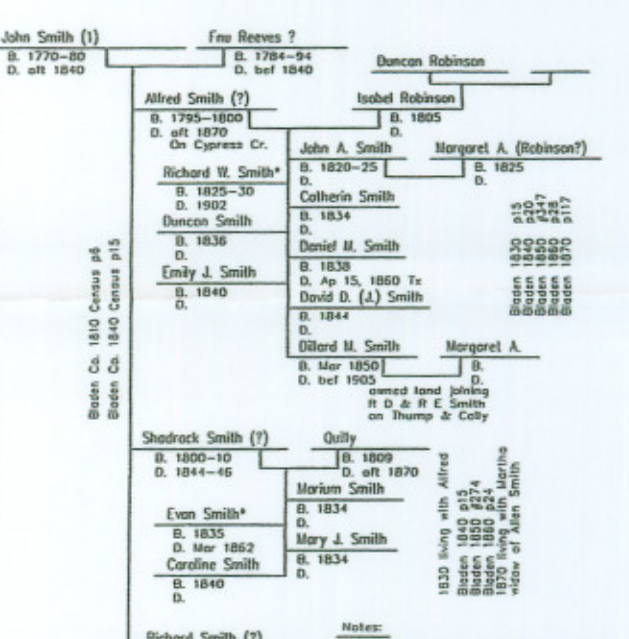
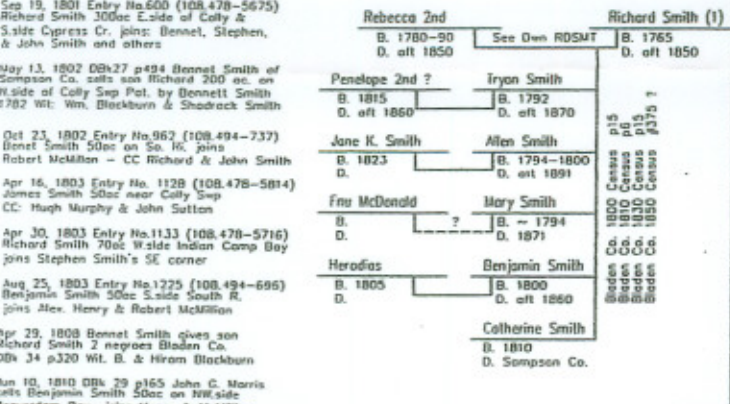
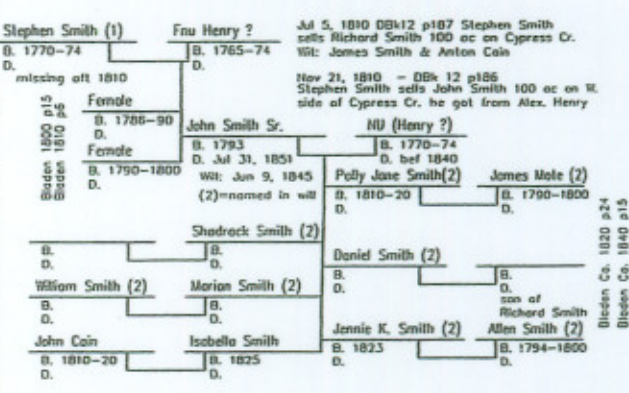
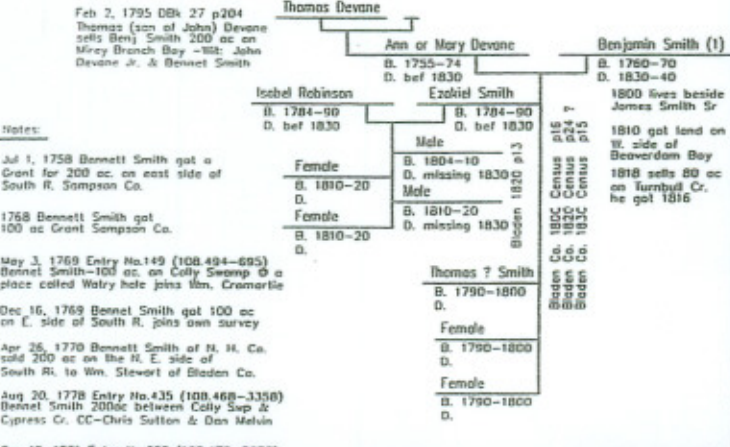
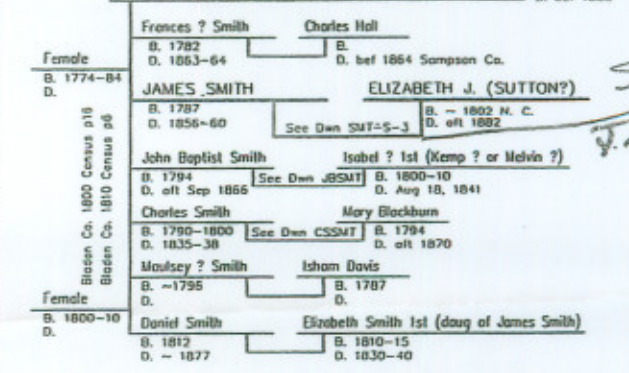
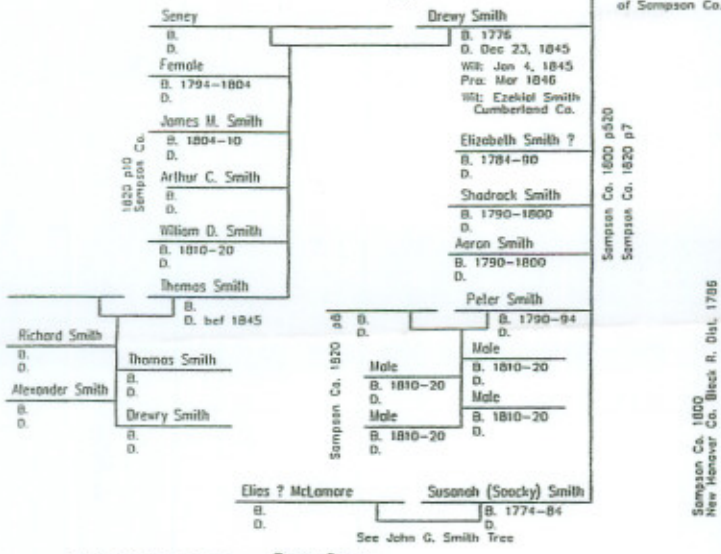
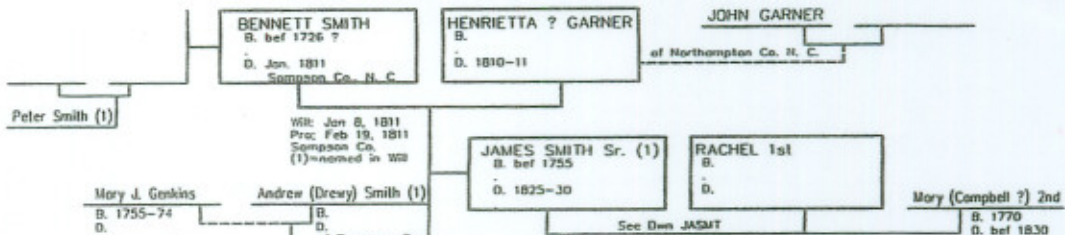

Aug 1832 Sampson Co. Court of P & O's There was a skirmish between the Lighthorse & Tories @ Bennett Smith's Residence on So. Rl.

Mar 18, 1845 Entry No. 85 (108-485-7553) R. W. Johnson's 100ac joined Equila Smith, Shadrack's father? John Smith was in area

SEE
 J. F. HALL

Bladen Co. 1820 p24
 Bladen Co. 1840 p15

Bladen Co. 1810 Census p6
 Bladen Co. 1840 Census p15

Bladen Co. 1830 living with Alfred
 Bladen 1840 p15
 Bladen 1850 p17
 Bladen 1860 p24
 Bladen 1870 living with Marjorie
 widow of Allen Smith

Notes:
 May 5, 1801 DB12 p365 Edward Reeves sells John Smith 100ac on W. side Cypress Cr. Will: John Davis & James Smith

May - 1801 DB12 p367 Edward Reeves sells John Smith 100ac on S. side Cypress Cr. Will: John Davis & James Smith

Jan 5, 1824 DBk 11 p265 Wm Reeves sells John Smith 316ac on E. side Colly joins Anders, Waddell & Burkes

Apr 3, 1836 Entry No. 1368 (108.469-693) Alfred Smith 50ac on E. side Colly CC: Richard & Allen Smith

JAMES SMITH
B. 1787
N. C.
D. 1850-1860
(1840-1845 ?)

ELIZABETH
B. ~ 1802
N. C.
D. After 1860

James McDaniel
B. 1804
D. After 1850
Ann Elizabeth Smith
B. 1814
D. After 1850
Susy, Luce, Polly, Patience

Female
B. 1810-1815

Iarmon Merit
Susan A.
B. 1817
D.
James J. Smith
B. 1817
D. 1855-1860
Molcy J. (Mills A.?)
B. 1838
D.
James Smith*
B. 1837
D. Fort Fisher
Sophia Smith
B. 1840
D.
Taylor Smith
B. 1843
D.
Jane Smith
B. 1845
D.
Robeson Smith
B. 1849
D.
William Smith
B. 1851
D.
George Smith
B. 1855

William D. Smith
B. 1816
D.
Darcus Ezzell
B. 1816
D.
Milton J. Smith
B. 1841
D.
John H. Smith
B. 1843
D.
Michael Smith
B. 1846
D.
Ratley Smith
B. 1848
D.
Penny E. Smith
B. 1849
D.

All are missing in Bladen Co. 1860

John Smith
B. 1819/1820
D.
Sarah A.
B. 1820
D.
Nathan J. Smith
B. 1842
D.
Betsey A. Smith
B. 1844
D.
James T. Smith
B. 1848
D.
Nancy Smith
B. Mar 1850
D.

Julia Ann Tatum
B. 1833
D.
Archibald Smith*
B. Feb 11, 1825
D. Feb 11, 1900

John Russ
B. Feb 6, 1855
D. May 2, 1921
Mary Ann Smith
B. Jun 7, 1851
D. Jul 30, 1915
William Henry Butler
B. Aug 9, 1854
D. Jan 1, 1897
Sarah M. Smith
B. 1854
D. Mar 11, 1897
Amanda C. Smith
B. ~ 1855
D.
Theophilus (Offie) Long
B. Jul 24, 1852
D. Dec 13, 1921
Julia Ann Smith
B. Apr 1858
D.
Elbert Smith
B. 1862
D.
Margaret Marie Smith
B. 1864
D. Dec 24, 1938
Marshall Devane Smith
B. Jul 1, 1870
D. Feb 11, 1893

ROBERT SMITH
B. Jan. 2, 1826
N. C.
D. Sept. 9, 1901
N. C.
REBECCA E. PETERSON
B. Sept. 12, 1834
Bladen Co. N. C.
D. Feb. 2, 1919
Bladen Co. N. C.
See Peterson Tree

See SMT-S-2
William James Smith
B. Oct. 23, 1858
D. Feb. 24, 1937
Maggie Lou Taylor (Alphin)
B. Mar. 22, 1862
D. Jun. 11, 1948
10 Children
Anna Elizabeth Smith
B. Dec. 24, 1859
D. Oct. 14, 1940
Henry Bridgen
B. D.
Gilead Smith
B. Aug. 18, 1861
D. Apr. 18, 1940
Annie J. Zibelin
B. Nov. 25, 1867
D. May. 18, 1909
Daniel W. Smith
B. Sep 15, 1863
D.
Emaline Smith
B. Feb. 14, 1865
D.
Edgar Leroy Smith
B. Feb. 7, 1867
D. Mar. 10, 1938
Katie B. Allen
B. Sep. 9, 1876
D. Mar. 1, 1919
ROBERT DIXON SMITH
B. May 14, 1869
Lagoon, Balden Co N. C.
D. Mar. 20, 1953
ELLA ALLEN
B. Oct. 22 1878
Kelly, N. C.
D. Mar. 31, 1933
See Allen Tree

Elizabeth J.
B. 1840
D.
Sion Smith
B. 1829 (1827)
D.

Mary Ann Smith
B. 1854
D.
Susan E. Smith
B. 1856
D.
James D. Smith
B. 1858
D.
Evander Wesley Smith
B. Aug 22, 1872
D.
Ellen C. Smith
B. 1864
D.
Preston Smith
B. 1867
D.
Alecius P. Smith
B. 1870
D.
Viola Smith
B. 1873
D.
Cornelia Smith
B. 1875
D.
Rebecca L. Smith
B. 1876
D.

Mary Jane Smith
B. Sep. 16, 1871
D. Dec 20, 1900
A. Dolphus Carter
B.
Rebecca Smith
B. D.
Dyson
B. D.
Nancy Lizzi Smith
B. Nov. 11, 1873
D.
Robert Bush
B. D.
Nannie L. Smith
B. Nov 11, 1874
D. Nov 6, 1953
Daniel Murdoch Currie
B. D.
Sally Catherine Maude Smith
B. Feb. 6, 1879
D. Oct. 31, 1961
7 Children
Willie Zibelin Marshall
B. Dec. 6, 1869
D. Jul. 19, 1943
Duncan Smith
B. Feb. 1881
D.
Pattie
B. D.

Sarah Carroll
B. D.
Daniel Smith*
B. 1834
D. Mar. 29, 1865
Elmira, N. Y.

Doctor Owen Smith*
B. Jun. 3, 1832
D. Oct. 2, 1885
Martha Ann Harvell
B. Oct. 30, 1830
D. Jun. 23, 1892
Darius Marchester Smith
B. Jun 2, 1858
D. Sep 29, 1927
Kate Jane McDonald
B. Jul 26, 1861
D. Aug 8, 1952
Ira Owen Smith
B. Jan. 6, 1862
D. Jul. 28, 1896
Artelia Smith
B. 1866
D.
Elvira C. Smith
B. 1871
D.

my GRANDFATHER
Margaret E. Davis
B. Aug 24, 1871
D. Oct 29, 1954
Daniel Lloyd Smith
B. Jan. 30, 1860
D. Mar. 16, 1931
Milton C. Smith
B. 1863
D.
Vera Smith
B. 1870
D.
Daniel J. Priest
B. Aug 4, 1857
D. Feb 17 1934
Mollie L. Smith 2nd
B. Nov. 16, 1872
D. Nov. 19, 1947

Hard C. Booth
Dundee Ct.
y. N. C. 27511-6514
9) 467-0582
(910) 467-8333

John Smith CYPRESS

no kin

